

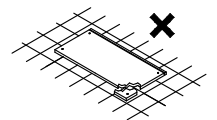

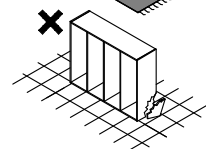

# LEXI R-14

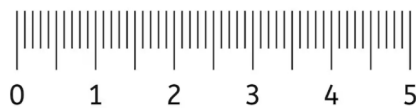

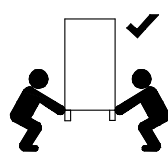
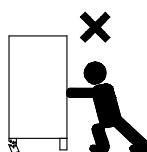
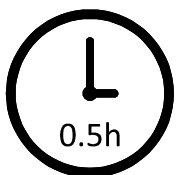
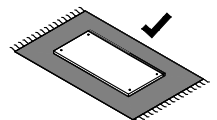
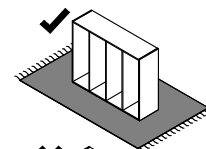
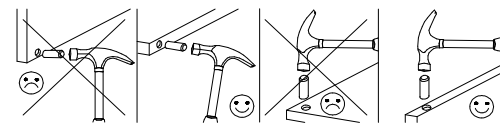
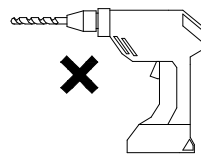
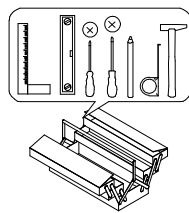
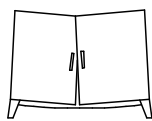
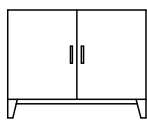
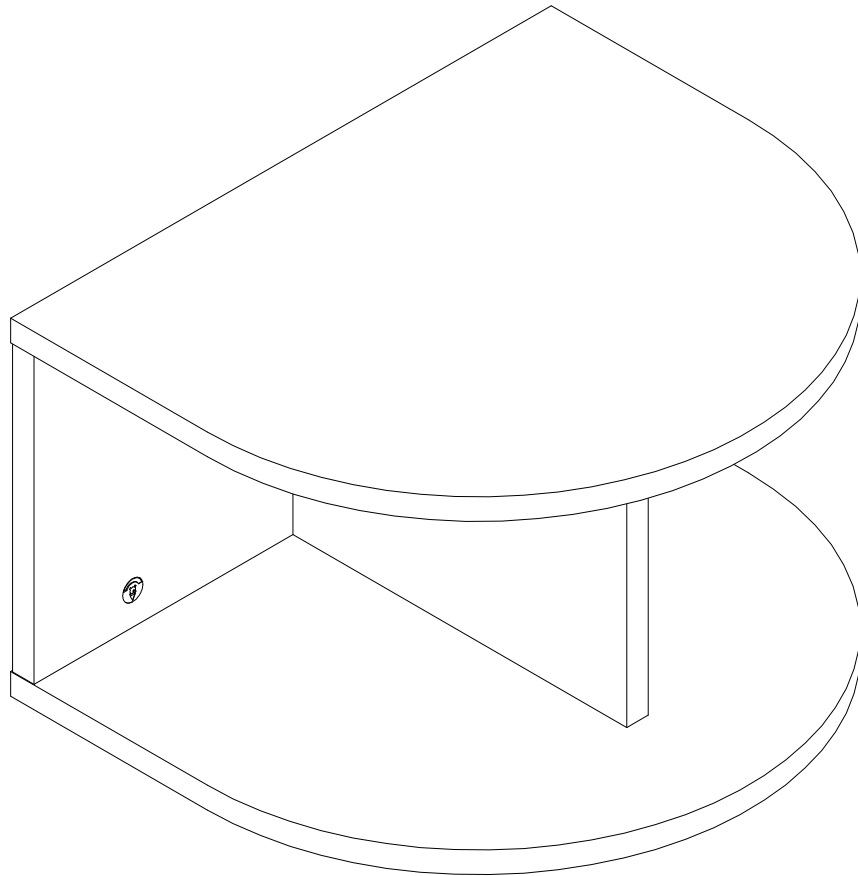
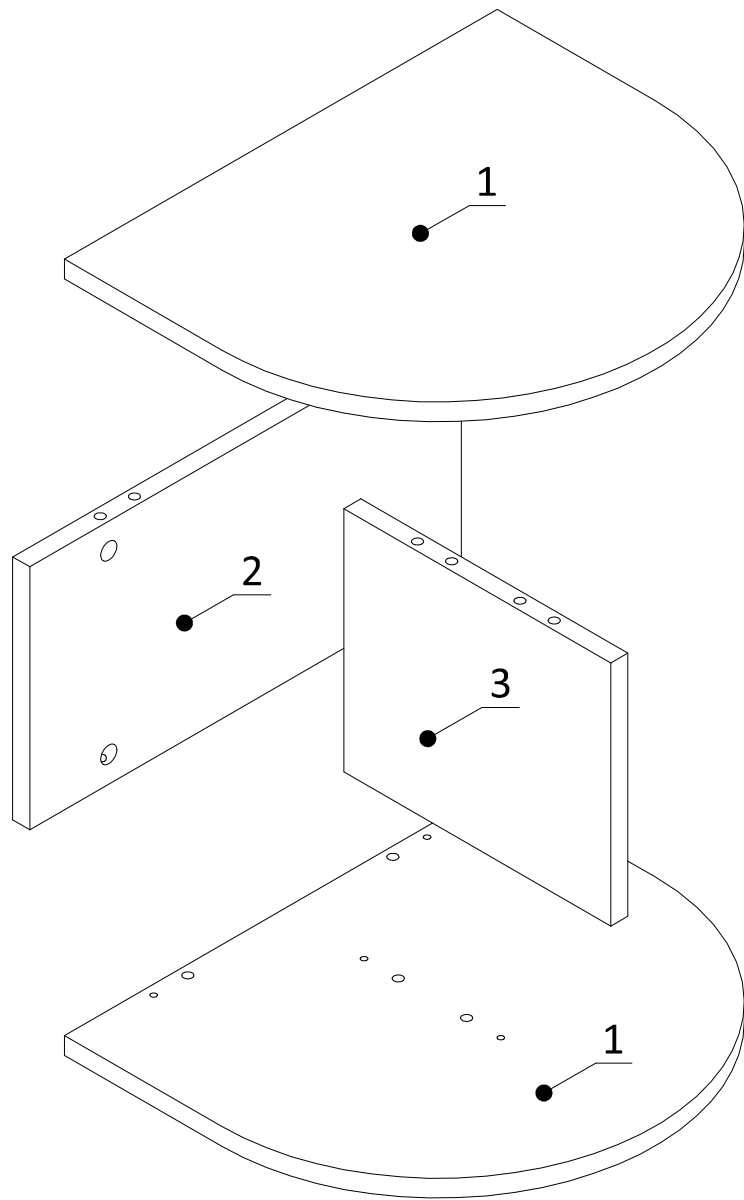
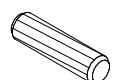

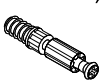
|   |  |  |   |   |
|---|--|--|---|---|
|  <p>80x30</p> |  <p>15/12</p> |  <p>L20,3</p> |  <p>ZM</p> |  <p>PF</p> |
| K   | M  | T  | ZM  | PF  |
| 8x  | 8x   | 8x   | 8x  | 4x  |

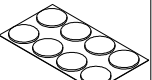
# 1

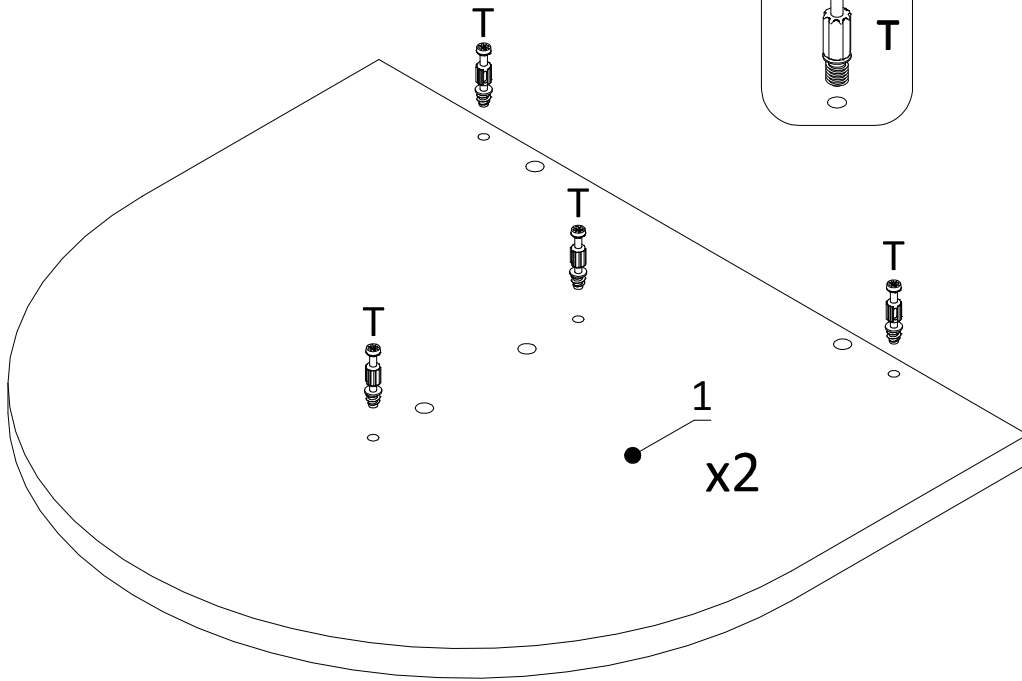

# 2

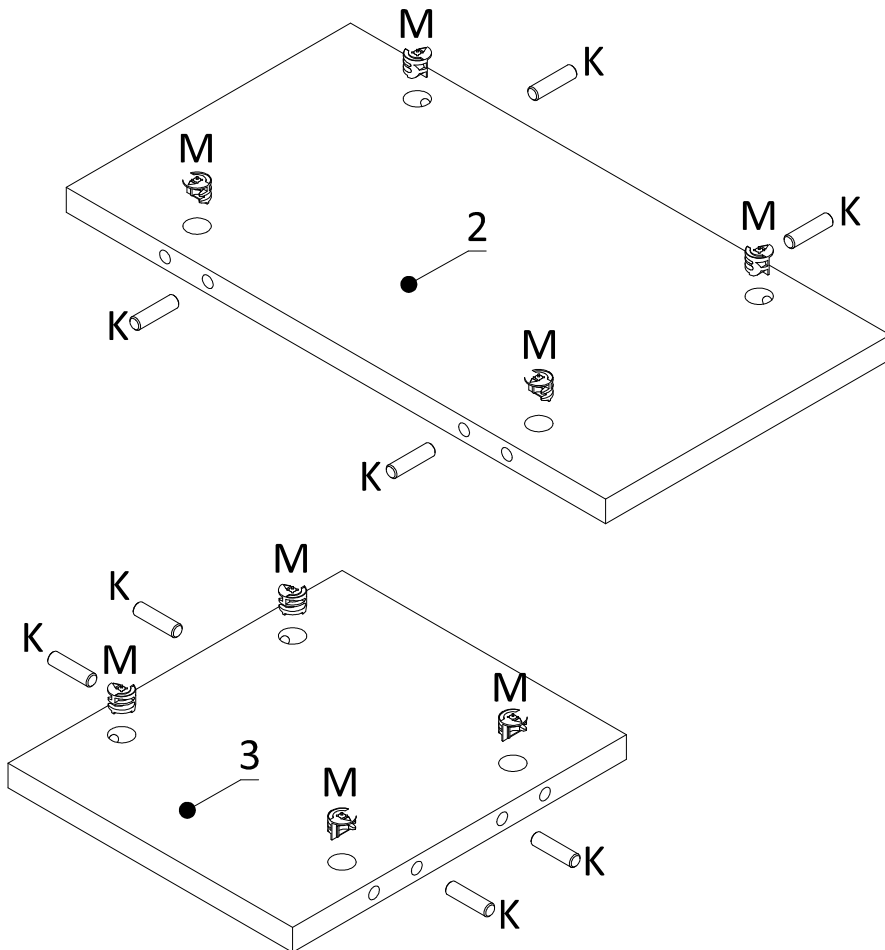

3

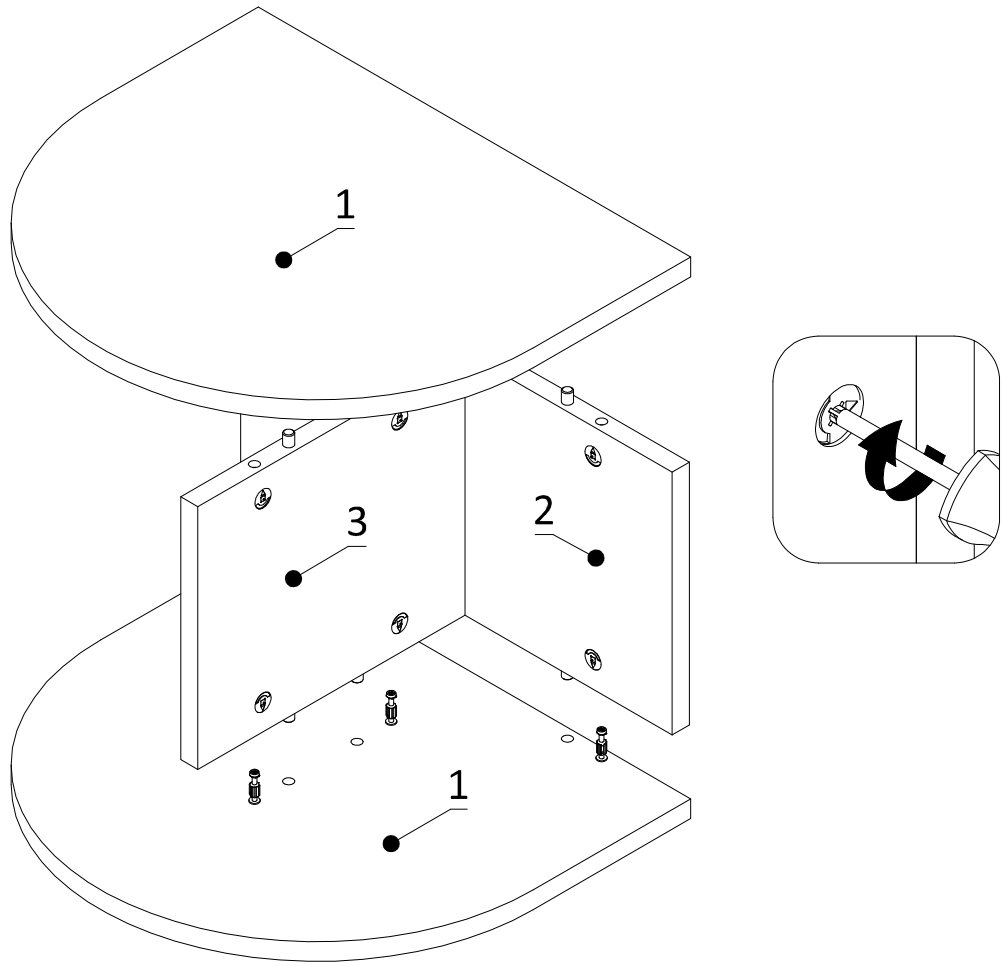

4

